

SL 215-8.6

ŽUMPA V=8,6m³

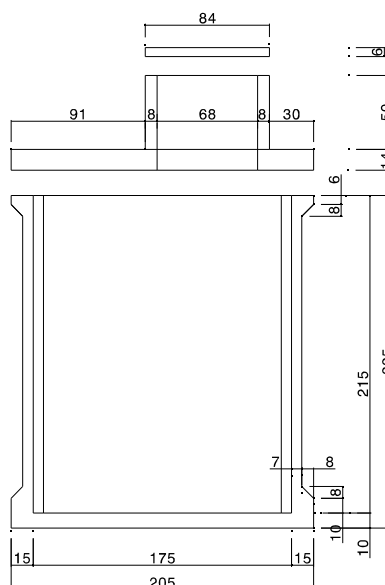
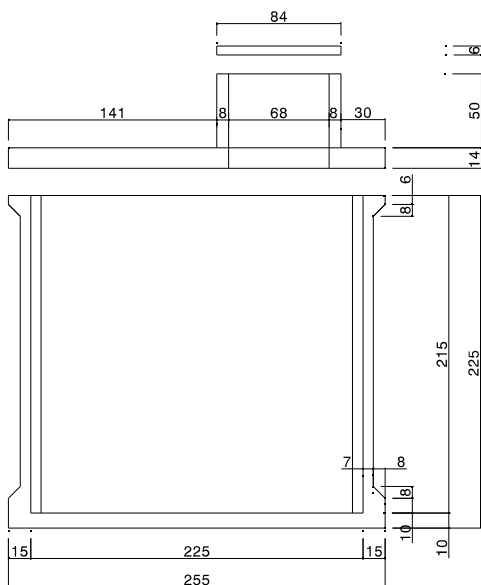
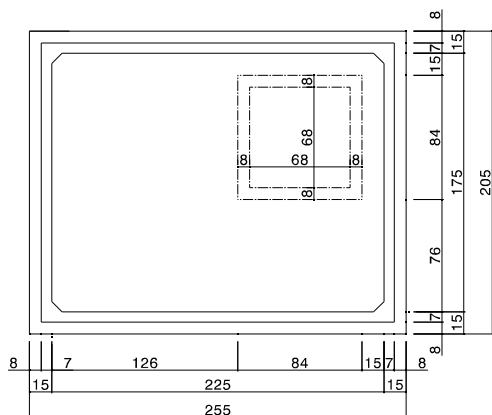
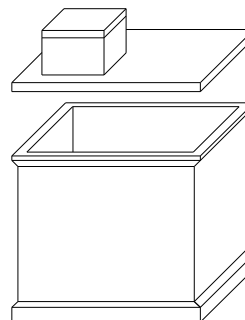

Kreslil	Ing. Havel Petr	www.ekomontsro.cz
Měřitko:	1:50	Prodejce: EKOMONT ing. Petr Havel Mlékojedská 2153/3 412 01 Litoměřice
Datum:	7.2011	
Výkres:	SL 215-8.6	